

Isuzu Diesel Engines

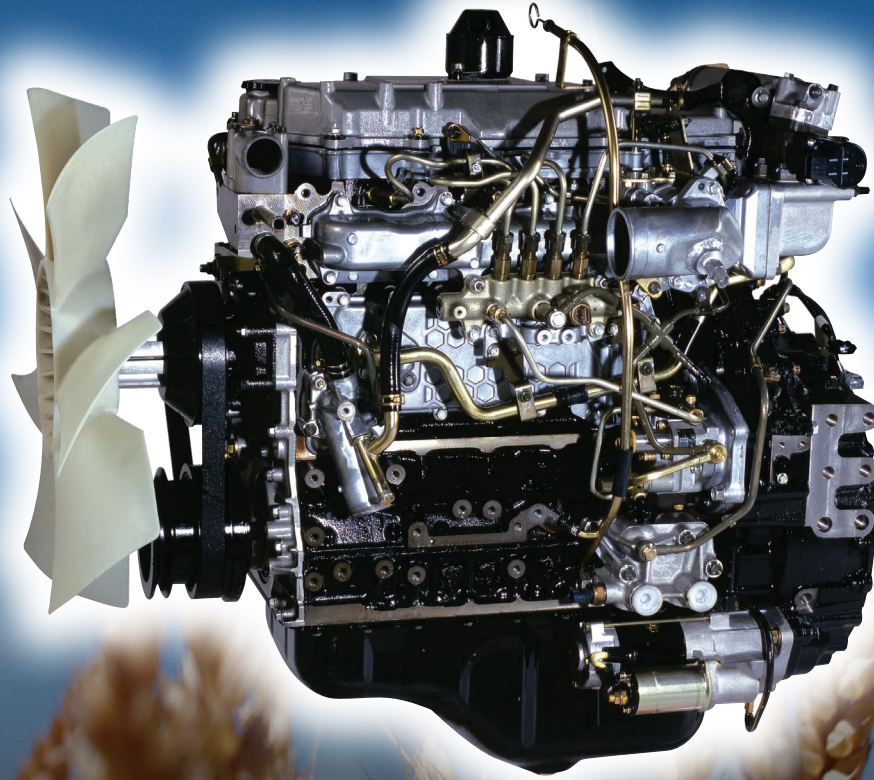

4HK1X

Generator: 178.2 HP @ 1800 RPM

Industrial Drive: 203.0 HP @ 2100 RPM

Standard features:

- U.S. EPA Tier 3
- Displacement: 5.2 L
- Turbo charged & charge air cooled
- Peak torque: 521.1 lb/ft @ 1500 RPM
- Fuel consumption: .356 LB/HP-HR
- Flywheel housing: SAE 3
- Electric & self-priming fuel lift pump
- 12V and 24V available
- Glow plug starting aid
- High angularity oil pan
- 500-hour service intervals
- 5-year / 5,000-hour warranty

The power behind it all.

ISUZU
DIESEL

Isuzu Diesel Engines

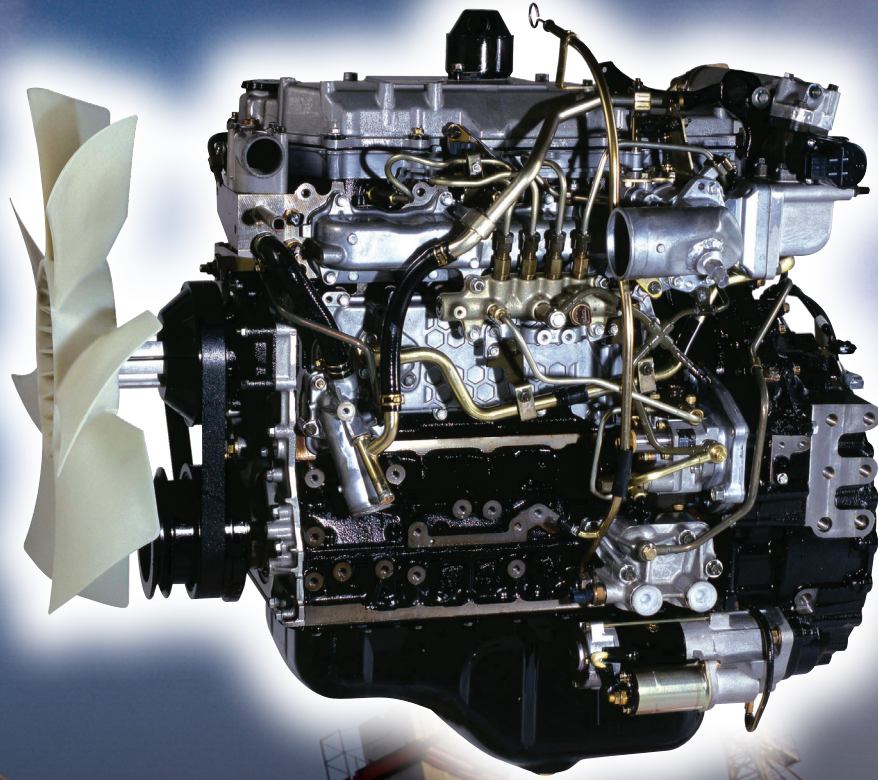

4HK1X

Generator: 178.2 HP @ 1800 RPM

Industrial Drive: 203.0 HP @ 2100 RPM

Standard features:

- U.S. EPA Tier 3
- Displacement: 5.2 L
- Turbo charged & charge air cooled
- Peak torque: 521.1 lb/ft @ 1500 RPM
- Fuel consumption: .356 LB/HP-HR
- Flywheel housing: SAE 3
- Electric & self-priming fuel lift pump
- 12V and 24V available
- Glow plug starting aid
- High angularity oil pan
- 500-hour service intervals
- 5-year / 5,000-hour warranty

The power behind it all.

ISUZU
DIESEL

Isuzu Diesel Engines

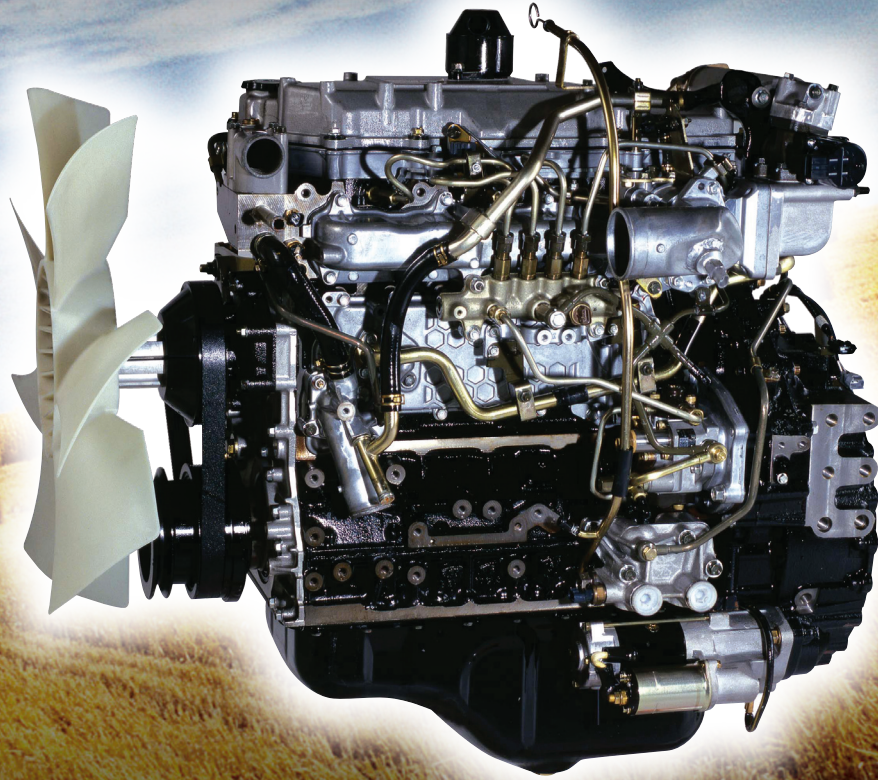

4HK1X

Generator: 178.2 HP @ 1800 RPM

Industrial Drive: 203.0 HP @ 2100 RPM

Standard features:

- U.S. EPA Tier 3
- Displacement: 5.2 L
- Turbo charged & charge air cooled
- Peak torque: 521.1 lb/ft @ 1500 RPM
- Fuel consumption: .356 LB/HP-HR
- Flywheel housing: SAE 3
- Electric & self-priming fuel lift pump
- 12V and 24V available
- Glow plug starting aid
- High angularity oil pan
- 500-hour service intervals
- 5-year / 5,000-hour warranty

The power behind it all.

ISUZU
DIESEL

4HK1X Industrial Performance Curves:

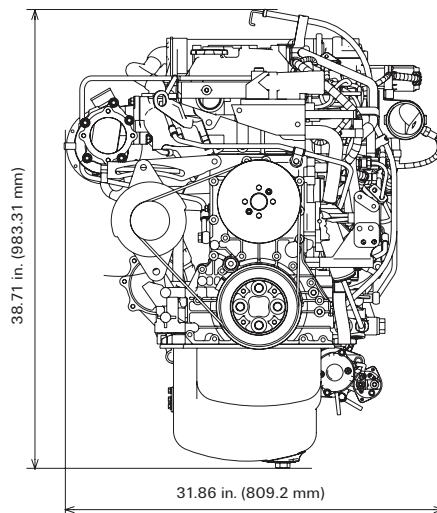
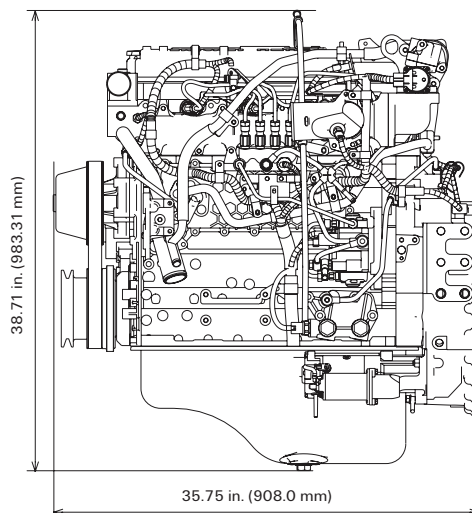
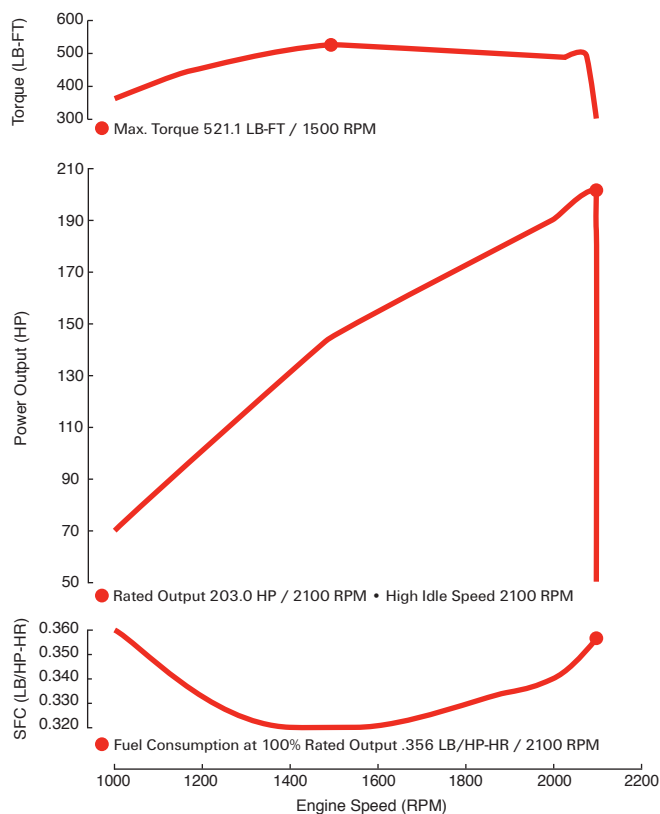

4HK1X Genset Performance Curves:

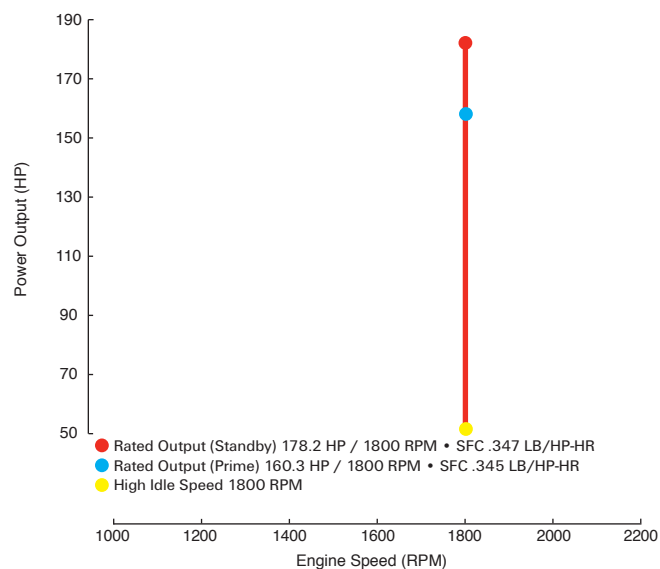

Available options:

- Cooling system
- Air cleaner
- Exhaust system
- Front and rear mounts
- Skid base
- Instrument panel & extension harness
- Custom power unit

Horsepower comparison:

Engine Model	Cylinders	Displacement (L)	HP Range
4JJ1X	4	3.0	75-130
4HK1X	4	5.2	150-200
6HK1X	6	7.8	225-300

For additional information, please contact your local distributor or visit www.isuzuengines.com

Isuzu Motors America, LLC

46401 Commerce Center Drive
 Plymouth, Michigan 48170
 Phone: 734.582.9470
 Fax: 734.455.7581

ILS-4HK1X-E

www.isuzuengines.com